

BRONYA

SUPERFINE HEAT INSULATION



**VOLGOGRAD
INNOVATION
RESOURCE CENTER**

WWW.NANO34.RU



Bronya heat insulation ensure high effective thermal insulation of building facades, roofs, interior walls, window jambs, concrete floors, hot water and cold water supply pipelines, steam pipelines, air ducts for the conditioning systems, cooling systems, various reservoirs, railway tanks, trailer trucks, refrigerator trucks, etc.

Bronya materials are intended to prevent any condensate on the cold water supply piping and reduce heat losses in the heating systems per SNIIP regulations. Bronya thermal insulation is applied in the temperature range of -60 °C to +260 °C. Minimum material lifetime is 15 years. Bronya thermal insulation materials are now used in the facilities and plants of multiple applications.

Presentation PATENTS



IT IS APPLIED AS A PAINT -
ACTS AS A THERMAL BARRIER

GK Volgograd Innovation Research Center (VIRC) Bronya has been in the market of liquid heat insulations since 2008. We have wide experience in development, manufacture and implementation of innovative construction materials providing the status of regular and conventional materials.

Besides, we have tremendous experience with large national companies such as Alrosa, Rosneft, Gazpromneft, Mosenergo, Russian Railways, Lukoil, Taman Neftegas, Quadra, Unipro which purchase our products for their projects. Our products were involved in capital repairs in the Crimea, Volgograd, Republic of Tatarstan, Khanti-Mansi Autonomous District, the Yamal-Nenets Autonomous District, in the cities of the Southern Federal District and the Central Federal District.

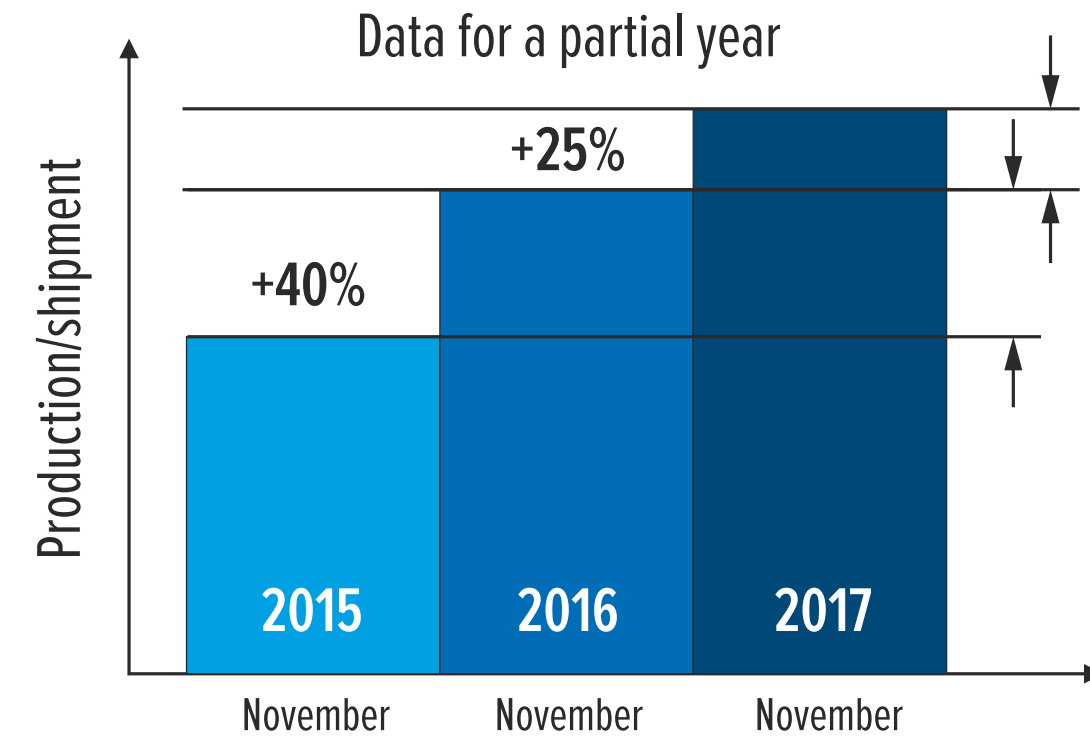
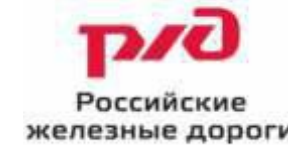

As of 2017 dealership network of GK VIRC Bronya includes more than 270 distribution centers in Russia and the Customs Union countries (Russian Federation, Republic of Belarus, and Republic of Kazakhstan). There is at least one distribution center in every large city. There are representative offices in all CIS countries, Baltic States and practically in all countries of the European Union. Representative offices are also available in the Arab countries such as Morocco, UAE, Saudi Arabia, Bahrain, as well as in Asian countries such as Indonesia, South Korea, China, Mongolia, Vietnam, New Zealand, and in Latin American countries such as Argentina, Chili and Ecuador. The required certification and testing were conducted internally by the regional distributors in all exporting

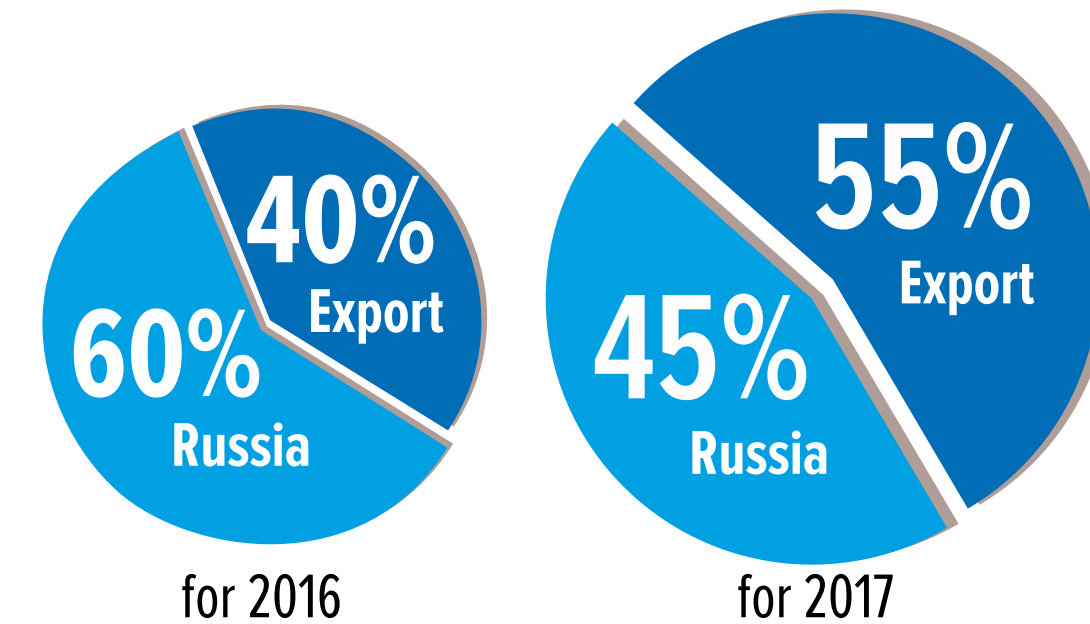

Certificates

IT IS APPLIED AS A PAINT -
ACTS AS A THERMAL BARRIER

The most important ten certificates, permits and patents are listed below :

- EC Declaration of Conformity
- Hygiene Certificate issued by the European Union
- Maritime Register
- Technical Approval of the Russian Federation State Committee for Construction, Architectural and Housing Policy
- Fire Safety Certificate G1
- Fire Safety Certificate NG
- Certificates issued by Moscow Construction Certification Body for each insulation modification
- Certificate issued by the Railway Research Institute (Russian Railways)
- Certificate issued by GazpromCert
- Hygiene Certificate



Bronya liquid ceramic heat insulating consists of high-quality acrylic binder, specially developed formulation of catalytic and fixing agents, superfine ceramic microspheres with rarefied air. The main composition of the material is supplemented by special additives that prevent development of corrosion on metal surface and growth of fungus on concrete surfaces in high humid environments. This combination makes the material light, flexible, and expandable and ensures its excellent adhesion to the surfaces being coated. In terms of consistence, the material is similar to common paint: it is white suspension that can be laid on any surface.

Thermal insulating materials are perfectly used in civil construction, housing and utility infrastructure, power engineering, oil and gas industry and at industrial facilities.



Thermal insulation of heat transport lines, steam pipelines and water supply pipelines



Thermal insulation of the building facades



Thermal insulation of trailers, railway cars and other means of transportation



Thermal insulation of storage tanks, reservoirs and vessels



Thermal insulation of the industrial equipment



Thermal insulation of the domestic facilities



When applying Bronya heat insulation you can save up to 50% due to low work labor input and application time. If you use Bronya heat insulating coats of 2 mm thick, heat losses from one running meter of the pipeline during heating season (5160 hours) are 36.8% (or 0.106 Gcal) less than heat losses from the pipeline insulated with 60 mm thick mineral wool.

Example: for pipelines of 100 running meter , the heat losses are the following:

Mineral wool: 0.394 (Gcal/5160 h per 1 m²) • 100 (m) • 640.7 (RUB/Gcal) = RUB 25 244 /5160h

Bronya insulation: 0.288 (Gcal/5160 h per 1 m²) • 100 (m) • 640.7 (RUB/Gcal) = RUB 18 452 /5160h

Thus application of Bronya superfine heat insulation makes it possible to make savings not only during application works but also after application. Considering the above said and service life of Bronya heat insulation we can CONCLUDE that this heat insulating material is highly effective in terms of its thermo-physical properties and from economic perspective.

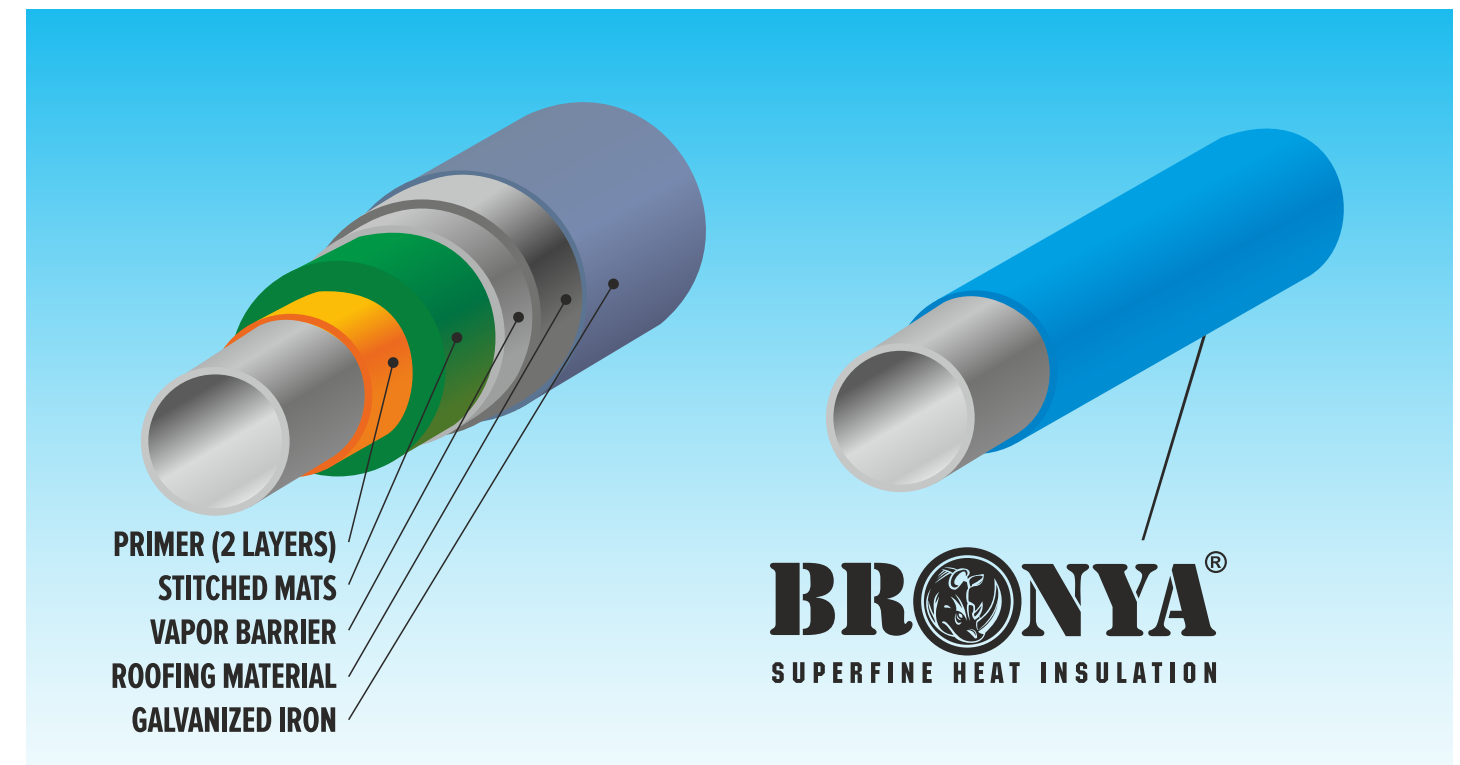



When using Bronya superfine heat insulation we can get the following economic profit:

- Manpower: by 114.71 man hours (reduction by 77%)
- Civil engineering machinery: by 1.07 machine hours (reduction by 36%)
- Materials : by RUB 502.66 /m2 (cheaper by 54%)
- Total estimated cost: RUB 1332.6 /m2 (cheaper by 60%)

Usage of Bronya superfine heat insulation gives you an opportunity to achieve similar thermo-physical properties versus the traditional insulating materials, while providing higher economic benefits during calculation of the total estimated cost. Besides, you should take into account service life of the materials (15 years for Bronya heat insulation and 5-7 years for mineral wool boards), possibility to perform repairs (you can easily perform repair works with Bronya heat insulation, while it is not practically possible with mineral wool boards), weather resistant properties (Bronya heat insulation is weather proof, mineral wool boards lose properties and aesthetic appearance when wet). Vapor permeability value of Bronya superfine heat insulation is identical to that of the reinforced concrete. It is easily applied in a single coat of 1–1.5 mm thick. Bronya heat insulation is not toxic, vandal-proof, UV-light resistant and long living.

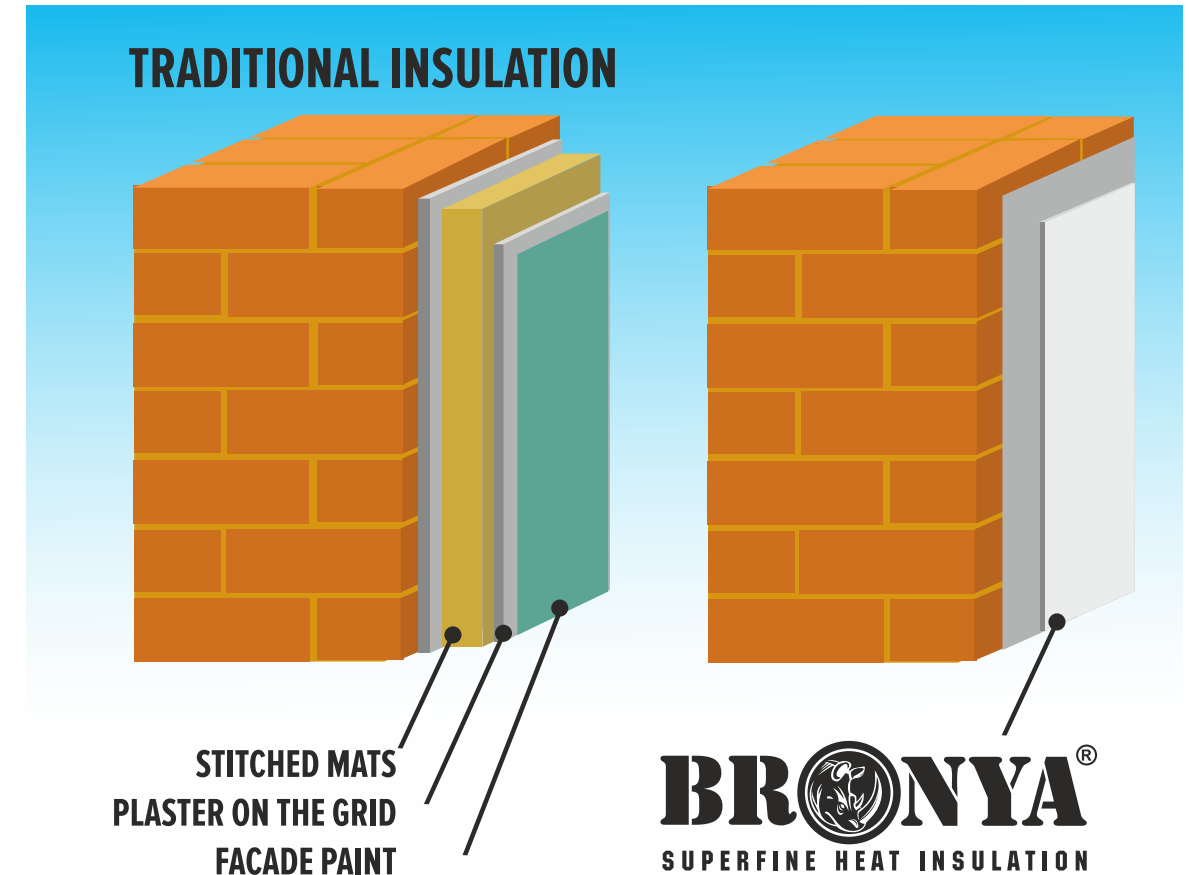

Thermal insulation of the building roofs using heat insulating material consisting of hollow microspheres helps to prevent ice, condensate and icicle formation. When you use Bronya liquid materials for roof heat insulation, you ensure protection of the roof against icicles and ice build-ups, as well as indoor condensate on the ceiling. High heat insulation and decorative performances plus extended service life are guaranteed.

- Increase of thermal resistance resulting in improved heat insulation of the construction without changing its architectural peculiarities;
- Protection against condensate formation;
- Protection against icicle forming and ice build-up;
- Simplified thermal insulation design and application process;
- Extended service life;
- Reduced completion time of the insulation works;
- Maintaining space of the objects to be insulated unchanged;
- Improved finishing quality of the buildings.

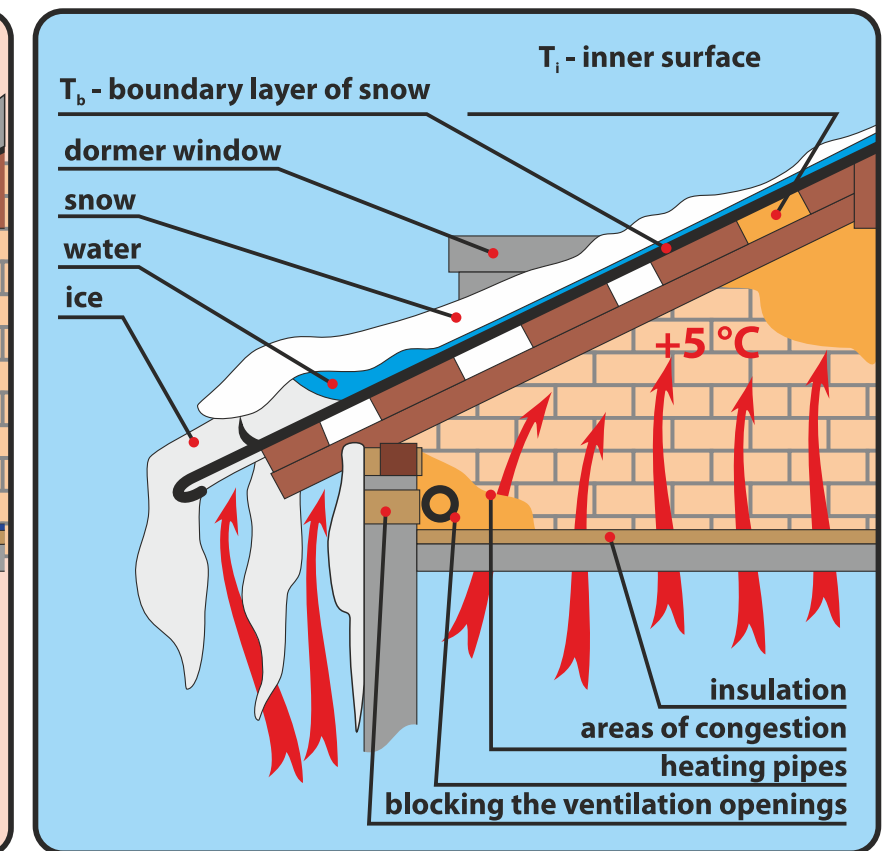
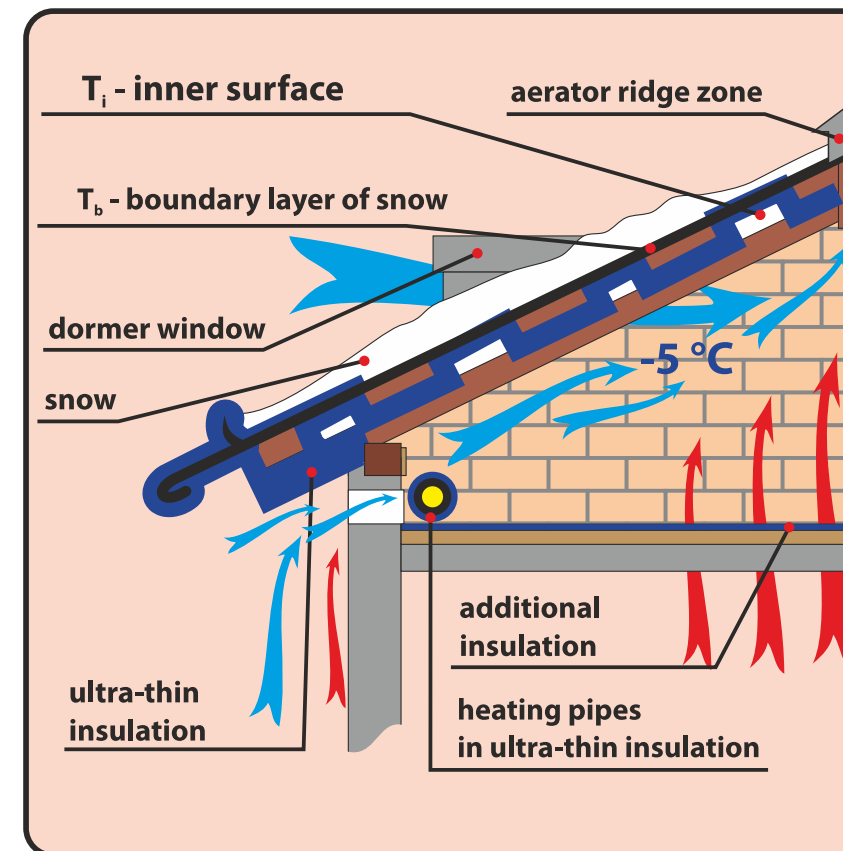



Heat insulation of the reservoir enclosures using mineral wool:

1. Corrosion prevention treatment of the reservoir;
2. Installation of the band fasteners;
3. 2 coats painting of the reservoir
4. Installation of mineral wool;
5. Mineral wool waterproofing;
6. Band installation;
7. Application of the top layer;
8. 2 coats finishing painting of the reservoir.

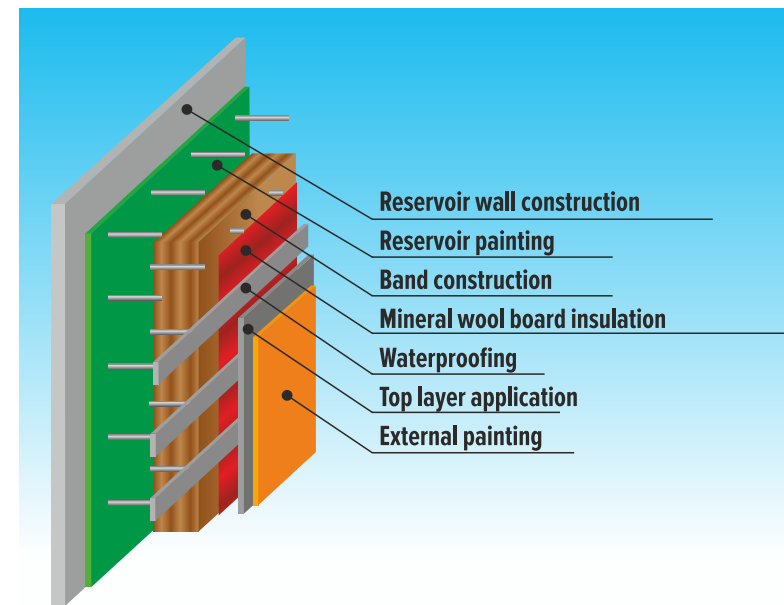

Standard technique of reservoir insulation



Thermal insulation and corrosion protection of the reservoir enclosures using Bronya liquid heat insulating materials:

1. Corrosion prevention and thermal insulation of the reservoir walls with Bronya liquid heat insulating materials

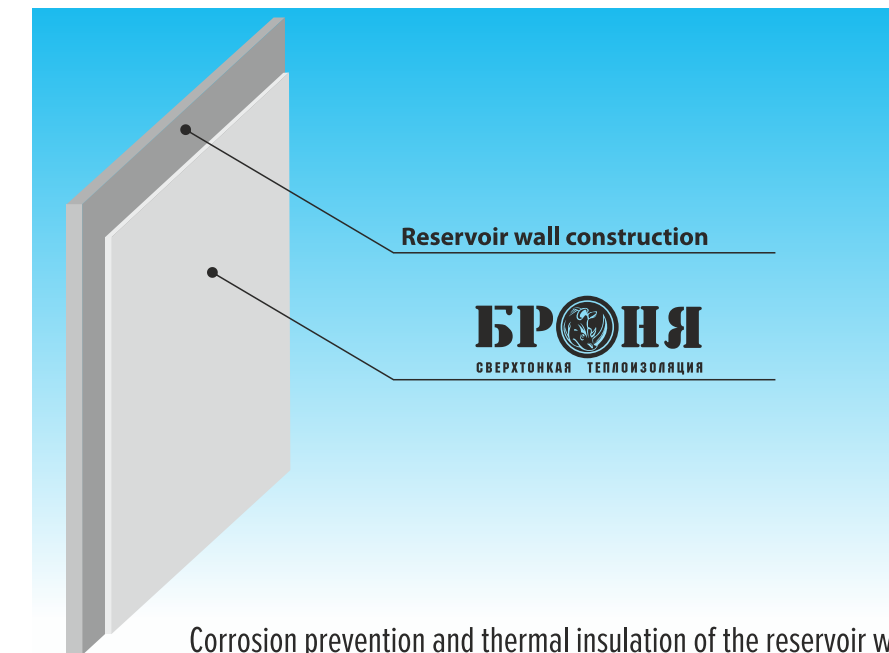

Corrosion prevention and thermal insulation of the reservoir walls with Bronya liquid heat insulating materials

Thermal Insulation protection from sunlight

IT IS APPLIED AS A PAINT -
ACTS AS A THERMAL BARRIER



It is used for thermal insulation of tanks, tanks, tankers and equipment.

It is performed on the inner and outer steel surface.

Allows:

- improve the thermal insulation properties of the tank or tank;
- significantly reduce the forced loss of liquids inside the tanks as a result of evaporation by reducing the temperature of the outer surface of the tank;
- to reduce the complexity of the work due to the high speed of application of thermal insulation coating;
- provide 100% coverage of the tank of any geometric shape;
- provide anti-corrosion protection of the material of construction;
- eliminate the formation of condensation;
- reduce the heating of the outer surface of the tank or tank from direct sunlight and solar radiation in the warm season

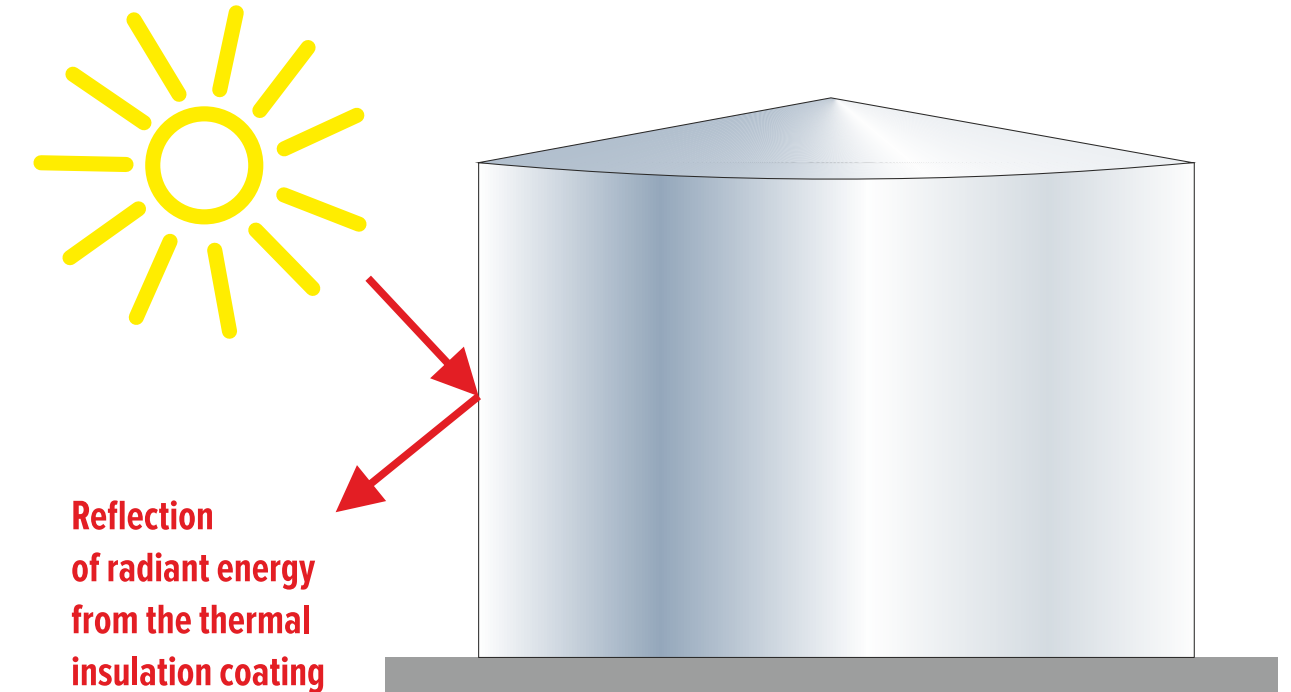

Insulation of transport

IT IS APPLIED AS A PAINT -
ACTS AS A THERMAL BARRIER



It is used for insulation of cars, railway tanks, trucks, tankers. It is performed on the inner and outer steel surface of the car body.

Allows:

- significantly reduce the weight of thermal insulation materials used;
- reduce the complexity of the work;
- provide 100% coverage of the car structure of any geometric shape;
- provide anti-corrosion protection of the material of construction;
- eliminate the formation of moisture condensate in the structure;
- reduce the average heat transfer coefficient of body fences;
- to improve the thermal insulation properties of the body of a railway tank or wagon;
- to reduce the heating of the outer surface of the body of a railway tank or wagon from direct sunlight and solar radiation in the warm season.

Pic. 1: 1 - the outline of the body of a railway tank or wagon, A - the sidewall of a railway tank or wagon.

Pic. A: 1 - part of the contour of the body of a railway tank or wagon, 2 - thermal insulation coating on the outside of the body of a railway tank or wagon, 3 - thermal insulation coating on the inside of the body of a railway tank or a wagon.

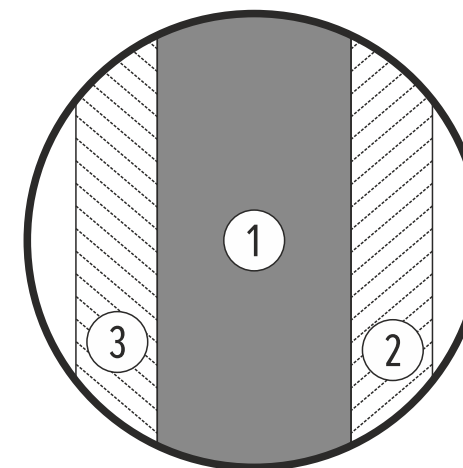
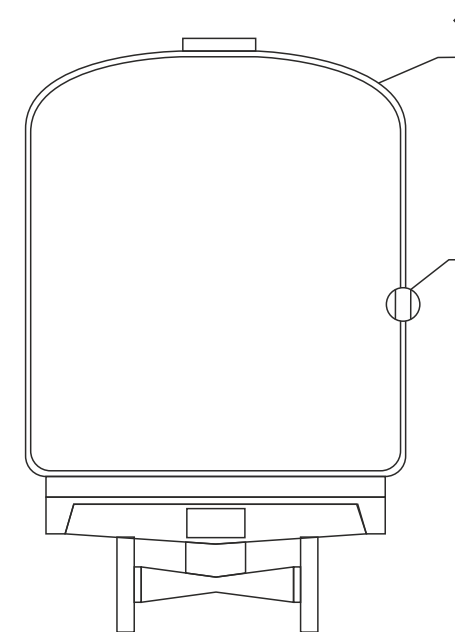

High-Temperature thermal insulation scheme

IT IS APPLIED AS A PAINT - ACTS AS A THERMAL BARRIER



It is used for thermal and anticorrosion insulation of external and internal enclosing structures, pipelines, air ducts of any configuration made of metal, plastic, concrete, brick and other building materials at operating temperatures from -60°C to +450°C.

"To extend the functionality by increasing the strength characteristics and thermal insulation properties, to enable use in a wide range of temperatures, to improve usability and efficiency, the thermal insulation coating contains at least one layer comprising a polymer binder and hollow microspheres, while it additionally contains a base of flexible material for the application of layers. Flexible material is made in the form of fabric or non-woven fabric. The flexible material is made in the form of fiberglass, or in the form of asbestos cloth or in the form of nonwoven asbestos cloth. The layers are located on one side and/or both sides of the base»

При комбинировании стекломата и Теплоизоляции Броня Классик происходит нивелирование (обнуление) зависимости эффективности от толщины слоя теплоизоляции. Каждый слой теплоизоляции Броня работает как первый миллиметр покрытия - с максимальной эффективностью.

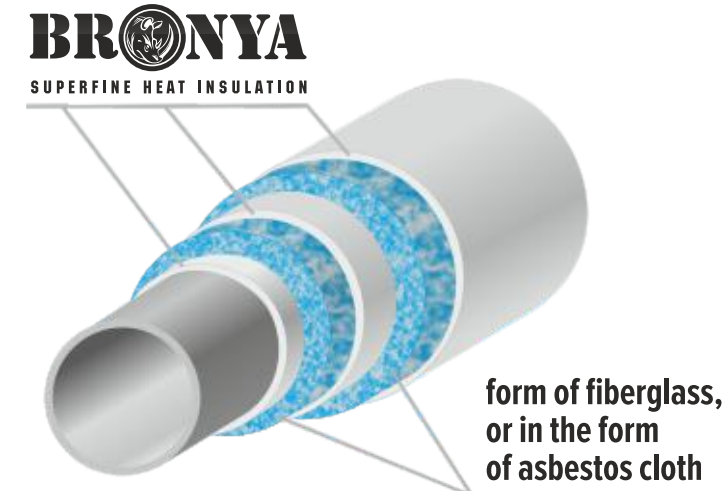



It is used to determine the thermal conductivity coefficient of liquid thermal insulation coatings, including the use of "Elcometer 319" and "PosiTensor DPM" devices to measure the temperature on the surface of the coating.

«Coefficient of thermal conductivity
 $\lambda = 0,0012 \text{ Вт/м}^\circ\text{C}$ »

$$\lambda = \frac{\delta \cdot \alpha_H \cdot (t_s - t_o)}{(t_T - t_n)}$$

where δ - the thickness of the liquid insulation;
 α_H - heat transfer coefficient from the surface;
 t_s - the temperature on the surface of the insulation;
 t_o - ambient temperature;
 t_T - the temperature of the heat source.



The surface of the Bronya can not be measured contact devices

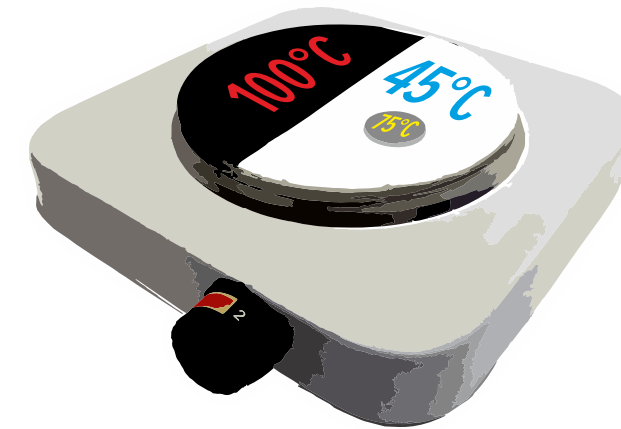

Accurate measurements of the Bronya can be made Elcometer® 319 or tactile test



Modifications

IT IS APPLIED AS A PAINT -
ACTS AS A THERMAL BARRIER



CLASSIC & CLASSIC NF

Basic product, applied as a paint, functions as thermal barrier!



UNIVERSAL & UNIVERSAL NF

Low cost version of Bronya Classic and Bronya Standard . Beneficial! Available now! Effective!



STANDARD & STANDARD NF

Budget-friendly version of Bronya Classic – similar thermo-physical properties, but with limitations of the maximum temperature of +140°C.



FIREPROTECTION & FIREPROTECTION NORD

Single-component composition intended to enhance fire retardant rating of the steel structures from 45 min to 120 min



ANTIRUST & ANTRUST NF

Unique insulating material which can be applied directly on the rusty surface



METAL & METAL NF

Low cost version of Bronya Antirust Beneficial! Available now! Effective!



FACADE & FACADE NF

High vapor permeability, can be used for enclosing structures of buildings and constructions



WALL & WALL NF

Low cost version of Bronya Facade. Beneficial! Available now! Effective!



WINTER & WINTER NF

Superfine heat insulation which can be applied at minus 35 °C



NORD & NORD NF

Low cost version of Bronya Winter. Beneficial! Available now! Effective!



LIGHT & LIGHT NF

Thermal insulation and sound-proof filler. Can be applied in thick coats, ensures perfect leveling of the surface to be insulated



PLYMERIC WATERPROOFING AQUABLOCK

This material is applied for waterproofing of roofs, projected and recessed balconies, floors, water closets, foundations, basements and other planes of irregular shape



ANTICONDENSATE

A single thick coat is applied directly on wet condensing surface. After drying this material protects against further condensation



SPECIALIZED COATINGS

Bronya superfine liquid ceramic heat insulating consists of high-quality acrylic binder, specially developed formulation of catalytic and fixing agents, superfine ceramic microspheres with rarefied air. In terms of consistence, the material is similar to common paint: it is white suspension that can be laid on any surface. Upon drying, it forms elastic polymeric coating that has unique heat-insulating properties. Thanks to its structure, the material has low surface heat transfer, which is crucial for the thermo-physical properties.

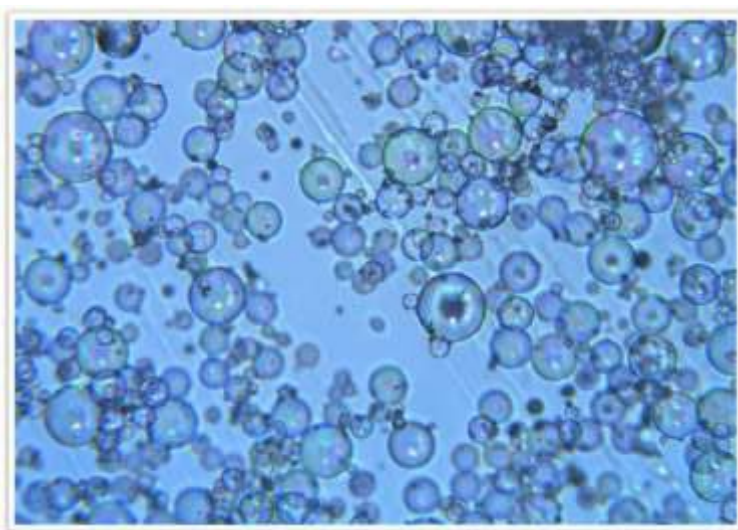

Microsphere through the microscope

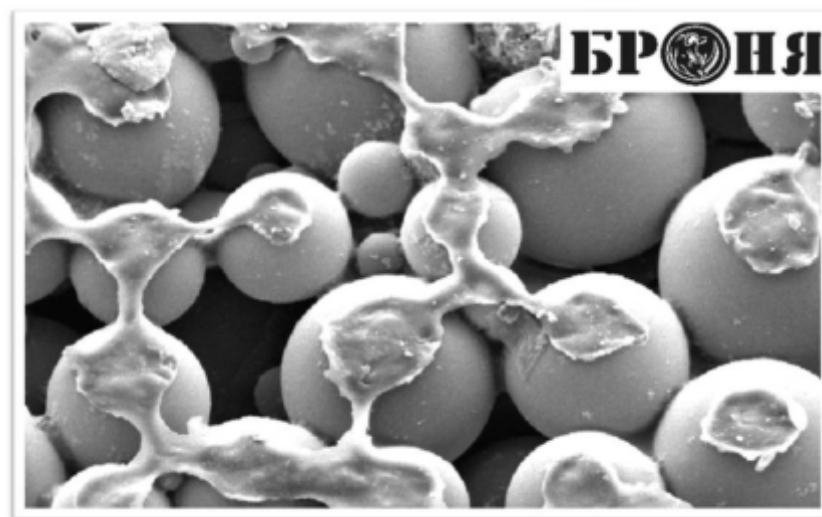

Bronya heat insulation through the microscope



Heat currents



Photo of the electric heater made by thermal camera, one half of the heater is coated with Bronya heat insulation